

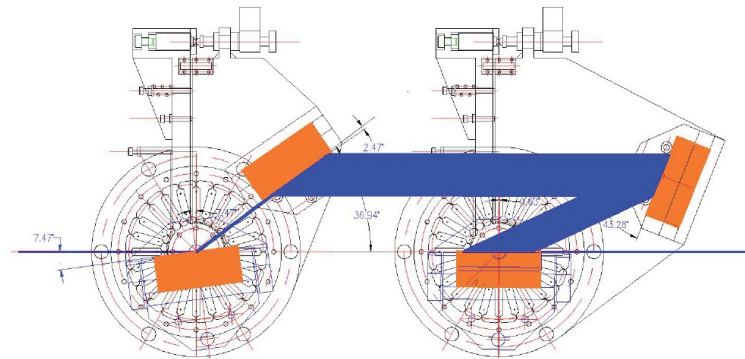

Nuclear Resonant Inelastic X-ray Spectroscopy (NRIXS)



Wolfgang Sturhahn

Dynamical behavior of atoms:

solids

phase transitions
diffusion
nanostructures
rotational excitations
superconductivity

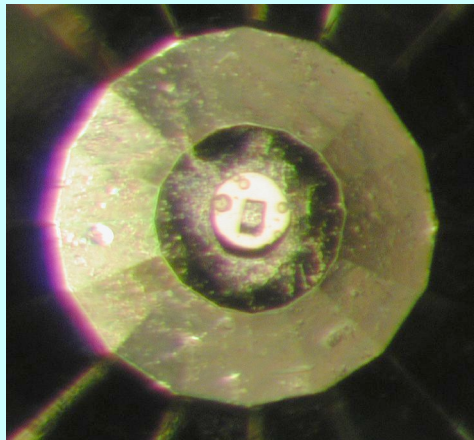

(Fe-sample in DAC)



(levitated Al_2O_3 -sample)

liquids

melting processes
viscosity
atomic clusters
glasses

gases

velocity distributions
confined systems



(methane escapes ice-chlathrate)

The nucleus as a probe:

➤ The nucleus is not at rest

- ☆ energy/momentum conservation ⇒ recoil energy shift
- ☆ velocity in gases ⇒ Doppler shift
- ☆ vibrations in solids ⇒ phonon excitation/annihilation, recoilless absorption

➤ NRIXS – Nuclear Resonant Inelastic X-ray Scattering (a.k.a. NRVS and NIS)

- ☆ local vibrational density of states
- ☆ applications include determination of sound velocities and thermodynamic properties

recent reviews of Nuclear Resonant Spectroscopy:

E. Gerdau and H. deWaard, eds., Hyperfine Interact. 123-125 (1999-2000)

W. Sturhahn, J. Phys.: Condens. Matt. 16 (2004)

R. Röhlsberger, Nuclear Condensed Matter Physics with Synchrotron Radiation: Basic Principles, Methodology and Applications, Springer (2004)

W. Sturhahn and J.M. Jackson, GSA special paper 421 (2007)



The two faces of nuclei:



➤ conventional role of nuclei

☆ majority carrier of the atomic mass

☆ carries the positive electric charge

☆ negligible scattering cross section:

$$\begin{aligned} \sigma(\text{nucleus}) / \sigma(\text{atom}) &= \\ (Z m/M)^2 &\approx 10^{-7} \\ (\text{Thomson}) & \end{aligned}$$

➤ but in some cases

☆ dynamics of the nucleons results in well-defined resonances with

$$\sigma(\text{nucleus}) / \sigma(\text{atom}) \approx 10^3$$

☆ nuclear resonant scattering may dominate

☆ nuclear resonances are extremely narrow

$$\Gamma / E \approx 10^{-12}$$

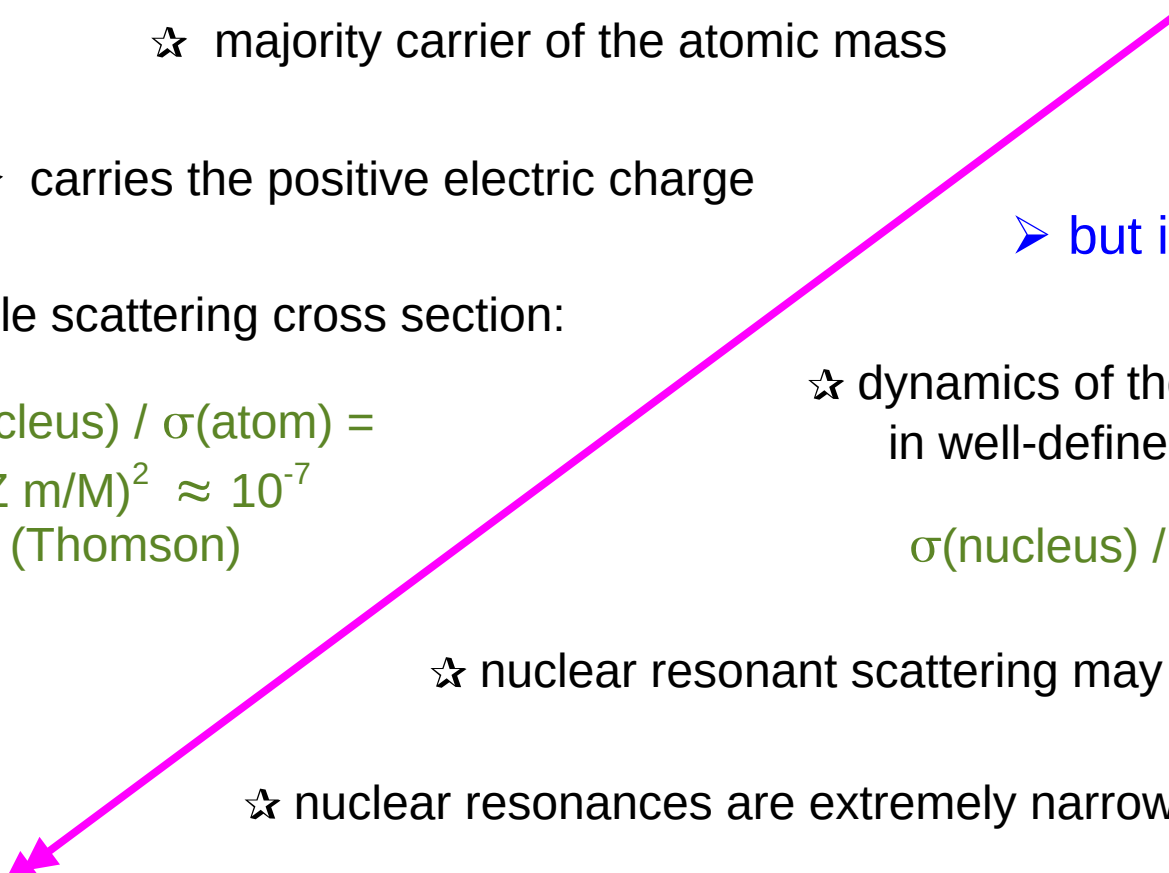

Excitation of the ^{57}Fe nuclear resonance:

fixed, isolated nucleus

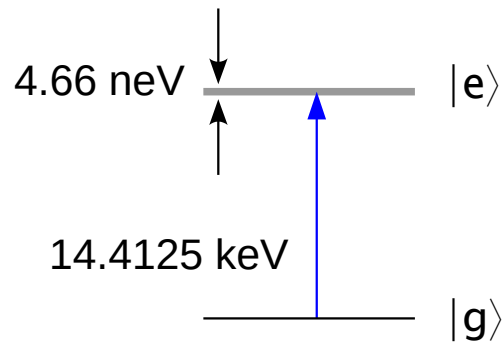

nucleus & electronic interaction or external fields

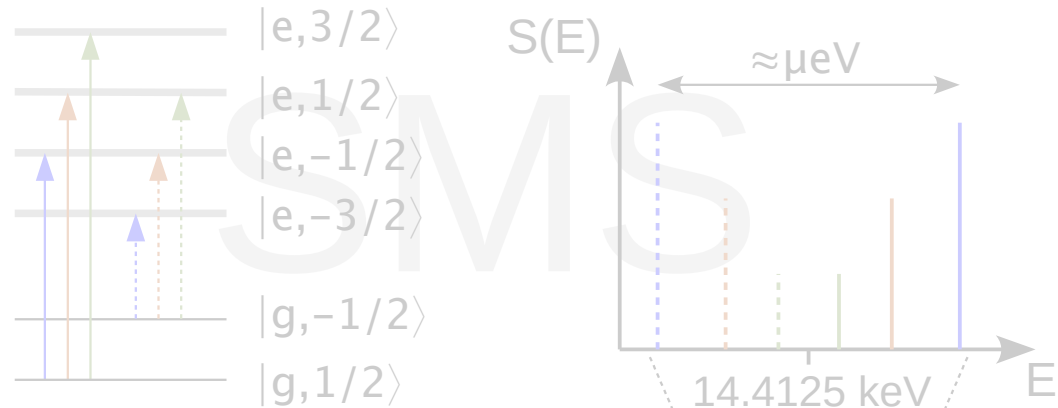

nucleus & simple lattice excitation

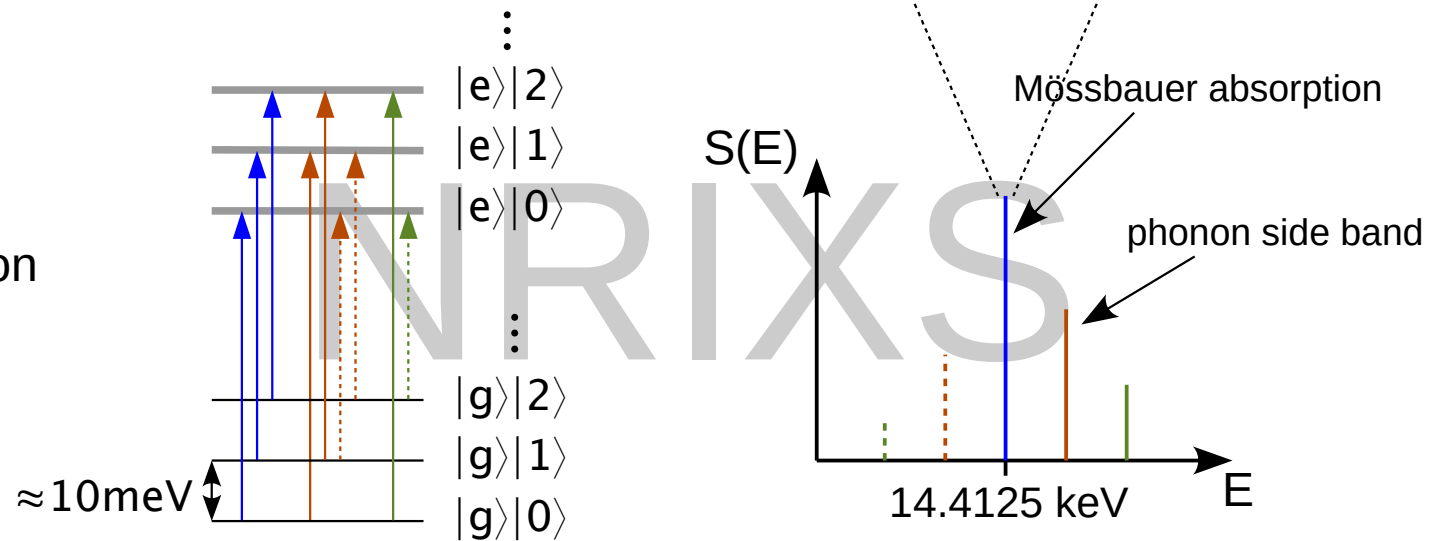

Scattering channels:

initial state → intermediate state → final state

$$\begin{array}{c}
 |\gamma_i\rangle |\Psi_i\rangle \longrightarrow |\Psi_n\rangle \longrightarrow |\gamma_f\rangle |\Psi_f\rangle \\
 \parallel \qquad \qquad \qquad \parallel \\
 |\chi_i\rangle \Pi_j |\phi_j^{(i)}\rangle \qquad \qquad \qquad |\chi_f\rangle \Pi_j |\phi_j^{(f)}\rangle \\
 \text{lattice} \qquad \qquad \text{nucleus \& core electrons}
 \end{array}$$

NRIXS

(negligible)

SMS

incoherent

$$|\phi_j^{(i)}\rangle \neq |\phi_j^{(f)}\rangle$$

coherent inelastic

$$|\phi_j^{(i)}\rangle = |\phi_j^{(f)}\rangle$$

$$|\chi_i\rangle \neq |\chi_f\rangle$$

coherent elastic

$$|\Psi_i\rangle = |\Psi_f\rangle$$

W.Sturhahn and V.Kohn
Hyperfine Interact. 123-124 (1999)



Cross section for nuclear excitation:

$$\sigma(E) = \frac{\pi}{2} \sigma_0 \Gamma S(E)$$

$\sigma_0 \sim$ nuclear resonant cross section

$\Gamma \sim$ width of the nuclear resonance

$S(E) \sim$ probability density for phonon excitation

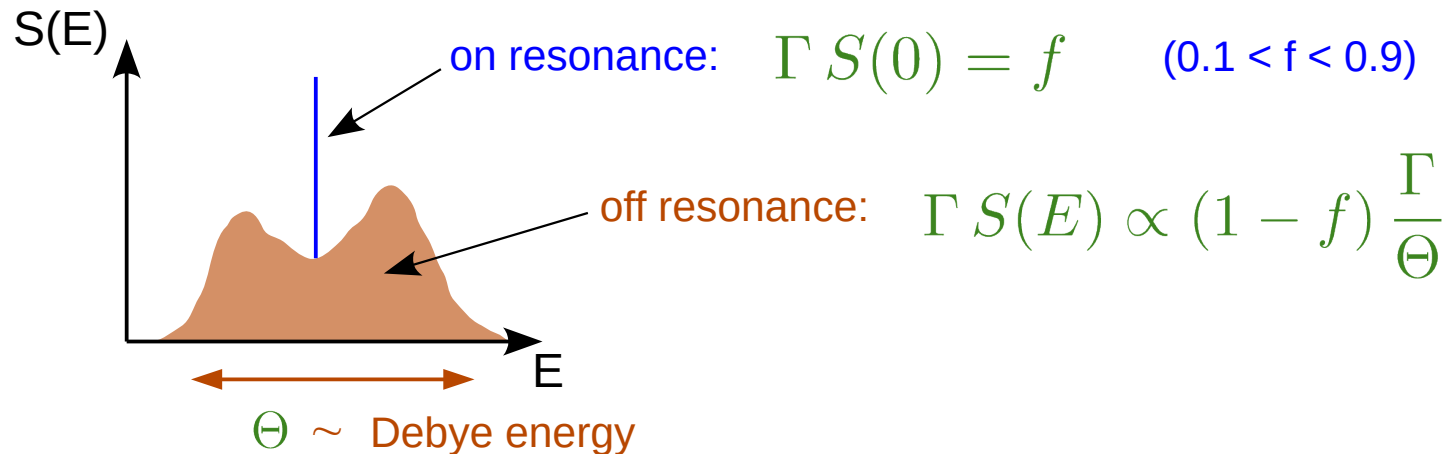

iron metal:

$$\sigma(0) = 560 \sigma_{pe}$$

$$\sigma(E) \approx 0.0002 \sigma_{pe}$$

$\sigma_{pe} \sim$ photoelectric cross section

W. Sturhahn, J. Phys.: Condens. Matter 16 (2004)



The time discrimination trick:

The excited nucleus decays incoherently with its natural life time τ .

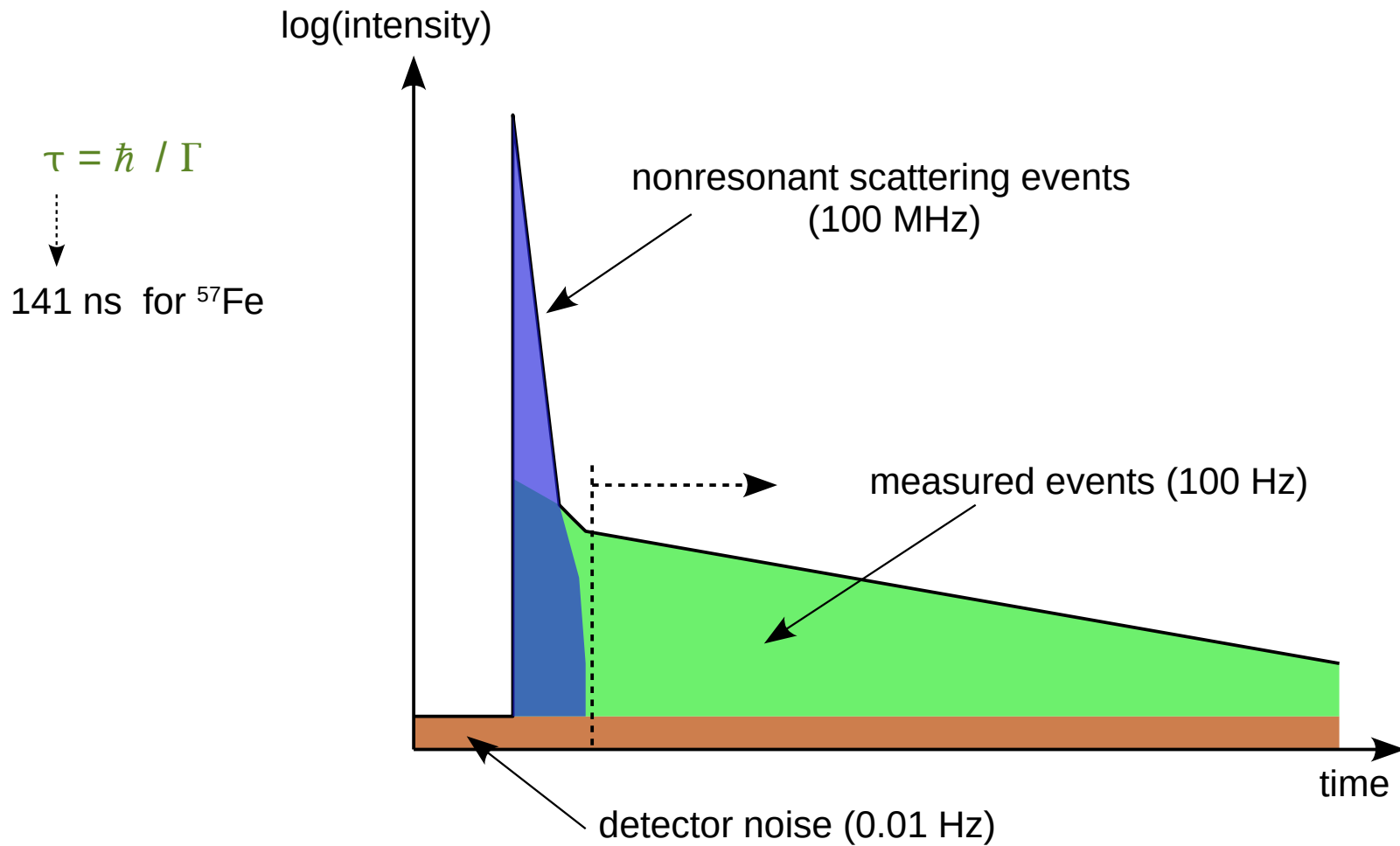

NRIXS, experimental setup:

- x-ray pulses must be sufficiently separated in time

- detectors must have good time resolution and excellent dynamic range

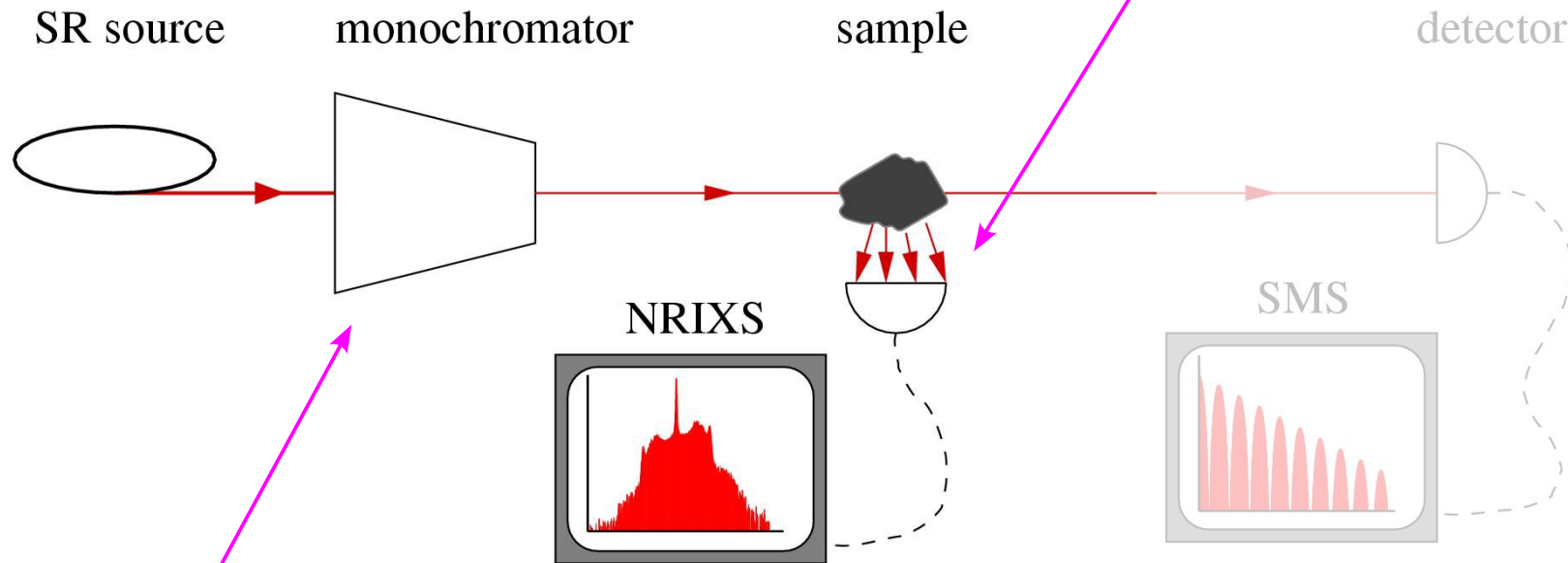

- monochromatization to meV-level required
- energy is tuned around nuclear transition



NRIXS, bcc-Fe:

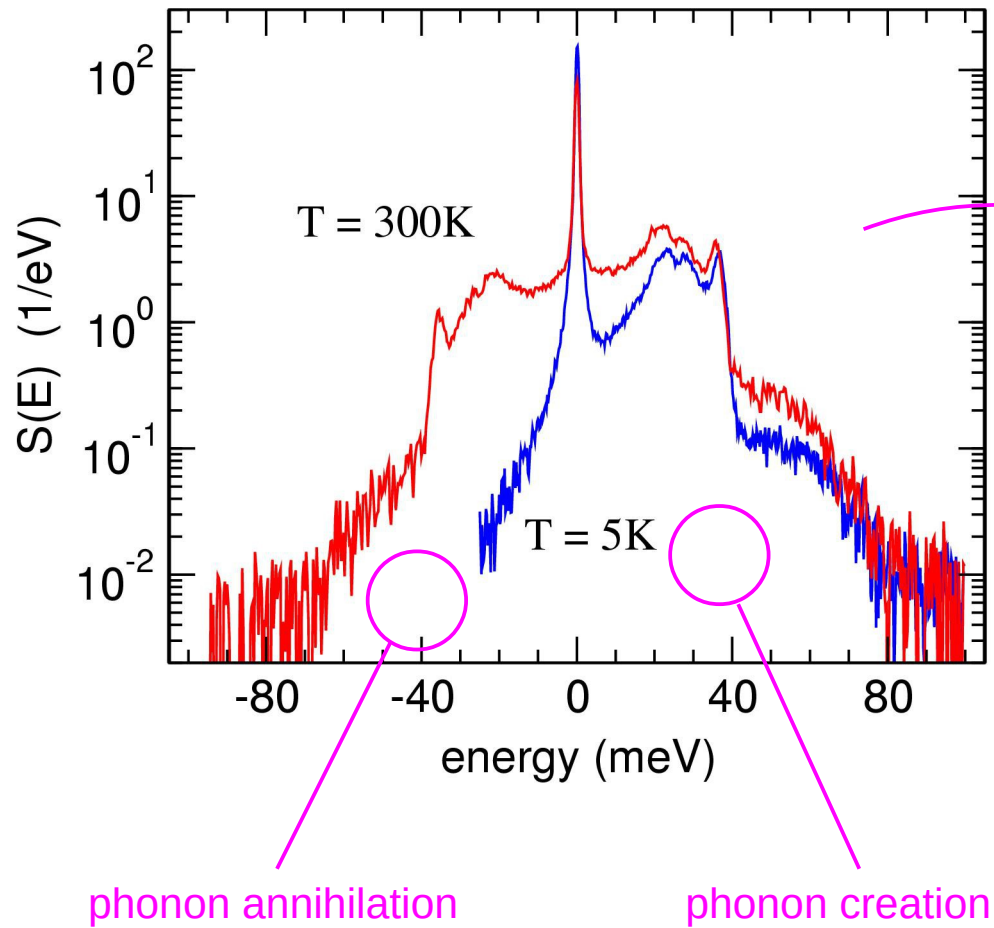

☆ the partial phonon DOS is extracted from the spectrum

V.G.Kohn et al., *Phys.Rev. B* 58 (1998)

M.Hu et al.,
Nucl.Instrum.Methods A 428 (1999)

W.Sturhahn,
Hyperfine Interact. 125 (2000)

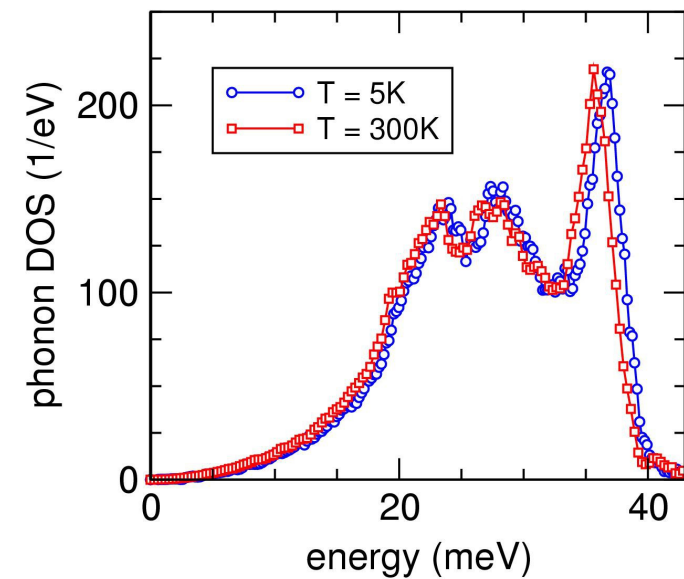

Interpretation of NRIXS spectra:

- NRIXS spectra directly provide the Fourier transform of the self-intermediate scattering function

$$S(\mathbf{k}, E) = \frac{1}{2\pi\hbar} \int \left\langle e^{i\mathbf{k}\hat{\mathbf{r}}(t)} e^{-i\mathbf{k}\hat{\mathbf{r}}(0)} \right\rangle e^{iEt/\hbar} dt$$

- In the quasi-harmonic approximation the partial projected phonon density-of-states is obtained by a multi-phonon expansion

$$S(\mathbf{k}, E) = f(\mathbf{k})\delta(E) + \sum_{n=1}^{\infty} S_n(\mathbf{k}, E)$$
$$S_1(\mathbf{k}, E) = f(\mathbf{k}) \frac{E_R}{E(1 - \exp[-\beta E])} g(\mathbf{k}, |E|)$$
$$S_n(\mathbf{k}, E) = \frac{1}{n f(\mathbf{k})} \int S_{n-1}(\mathbf{k}, E') S_1(\mathbf{k}, E - E') dE'$$
$$f(\mathbf{k}) = \exp \left[- \int \frac{E_R}{E} \coth\left(\frac{\beta E}{2}\right) g(\mathbf{k}, E) dE \right]$$

W.Sturhahn and V.G.Kohn, *Hyperfine Interact.* 123/124 (1999)



Information from NRIXS spectra:

➤ directly from the data, $S(E)$

⇒ temperature

$$T = -\frac{E}{k_B} \ln \left[\frac{S(-E)}{S(E)} \right]$$

⇒ mean square displacement

$$\langle u^2 \rangle = -\frac{1}{k^2} \ln \left[1 - \int \{S(E) - S(0)\} dE \right]$$

⇒ kinetic energy

$$E_{kin} = \frac{1}{4E_R} \int (E - E_R)^2 S(E) dE$$

⇒ average force constant

$$D = \frac{k^2}{2E_R^2} \int (E - E_R)^3 S(E) dE$$

k ~ wave number of nuclear transition

E_R ~ recoil energy

ρ ~ mass density

➤ quasi-harmonic lattice model

⇒ partial phonon density of states

$$\mathcal{D}(E)$$

⇒ Debye sound velocity

$$v_D = \left(\frac{M}{2\rho\pi^2\hbar^3} \frac{E^2}{\mathcal{D}(E \rightarrow 0)} \right)^{1/3}$$

⇒ Grüneisen parameter

$$\gamma_D = \frac{1}{3} + \frac{\rho}{v_D} \left(\frac{\partial v_D}{\partial \rho} \right)_T$$

⇒ isotope fractionation

$$\ln \beta = -\frac{\Delta m}{M} \frac{1}{8(k_B T)^2} \int E^2 \mathcal{D}(E) dE$$

M ~ mass of resonant isotope

Δm ~ isotope mass difference

k_B ~ Boltzmann's constant

T ~ temperature



Methods:

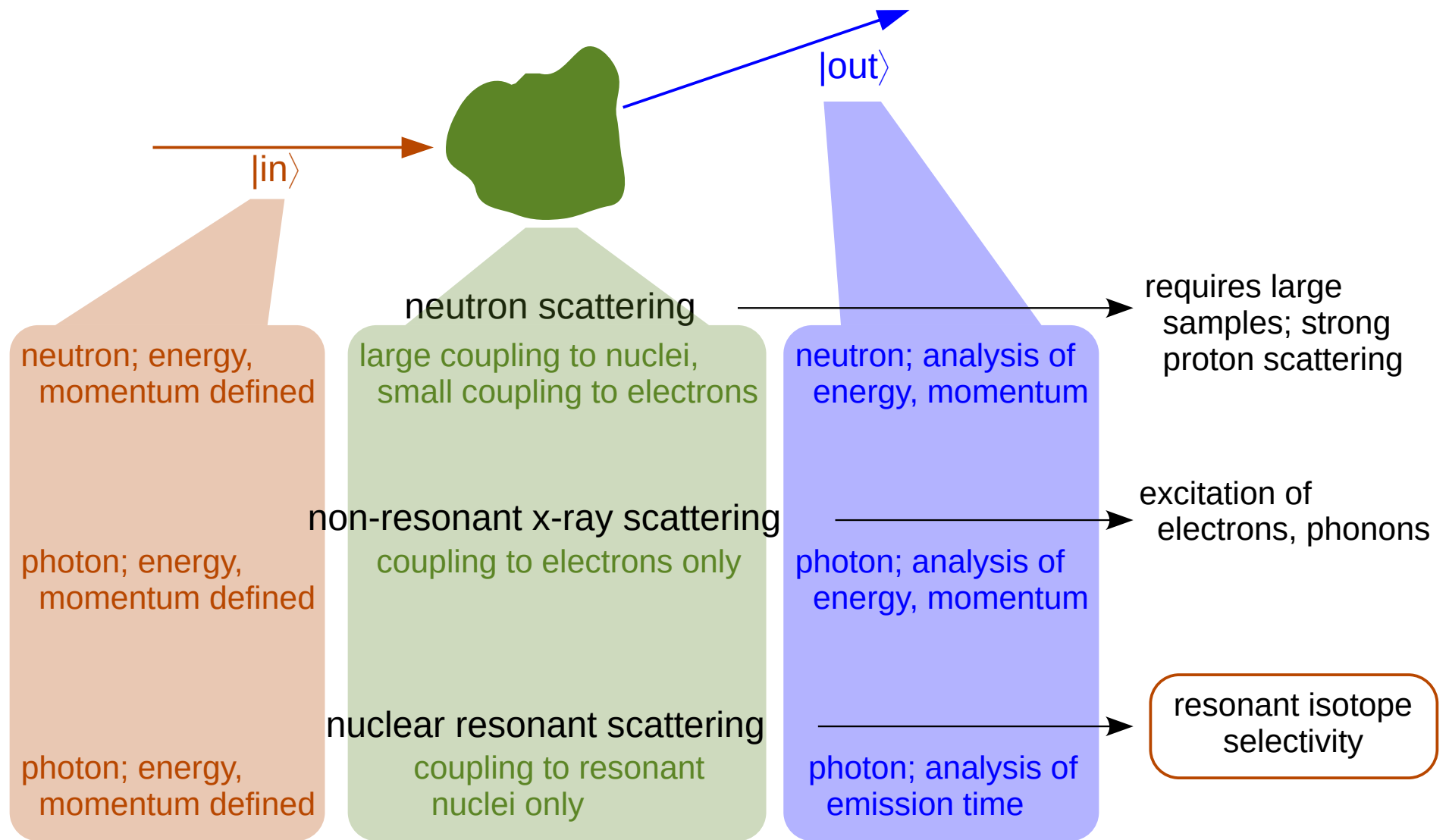

Isotopes for nuclear resonant scattering:

larger scattering strength



easier timing

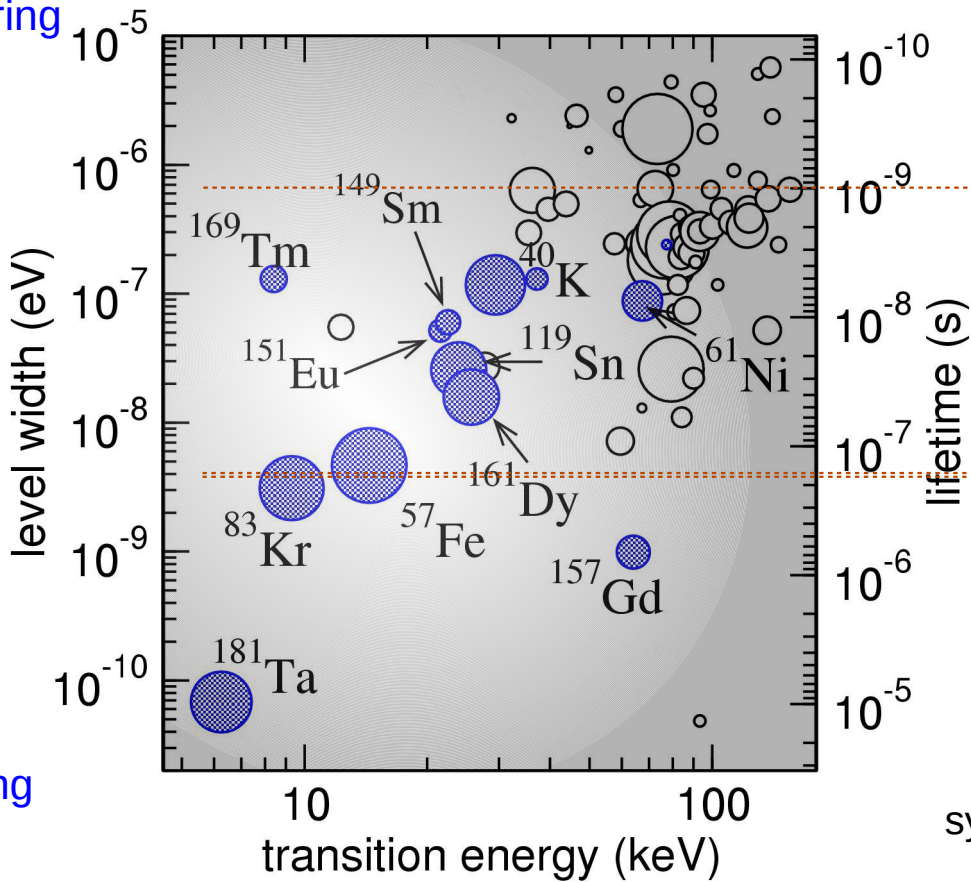

detector resolution

APS, ESRF bunch separation

symbol area is proportional to the nuclear resonant cross section

more absorption ← → less intensity



Time structure of synchrotron radiation:

detector dead time and bunch separation determine the detectable counts in NRIXS.

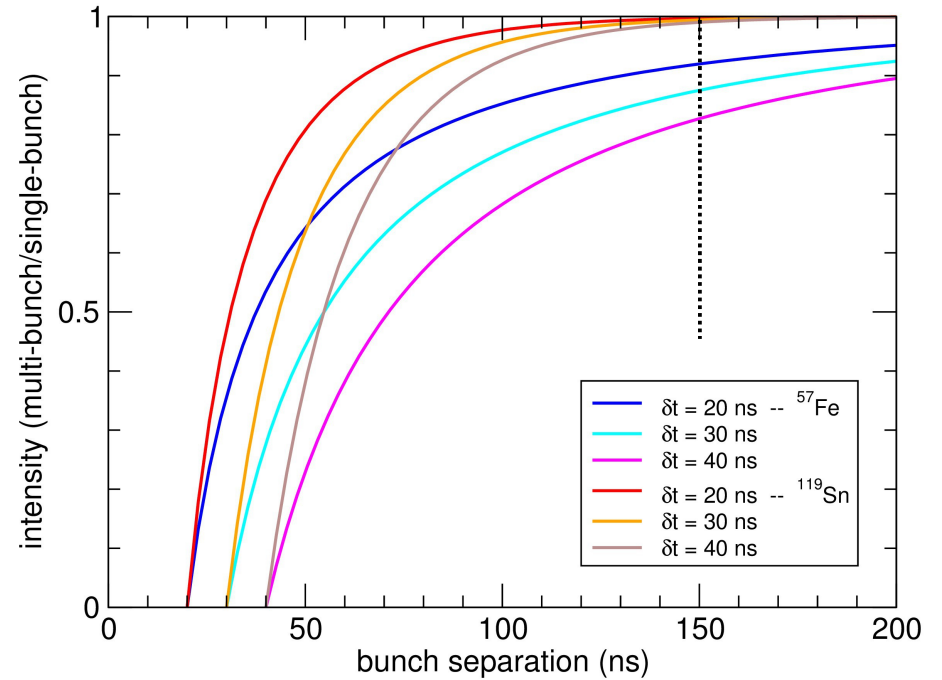
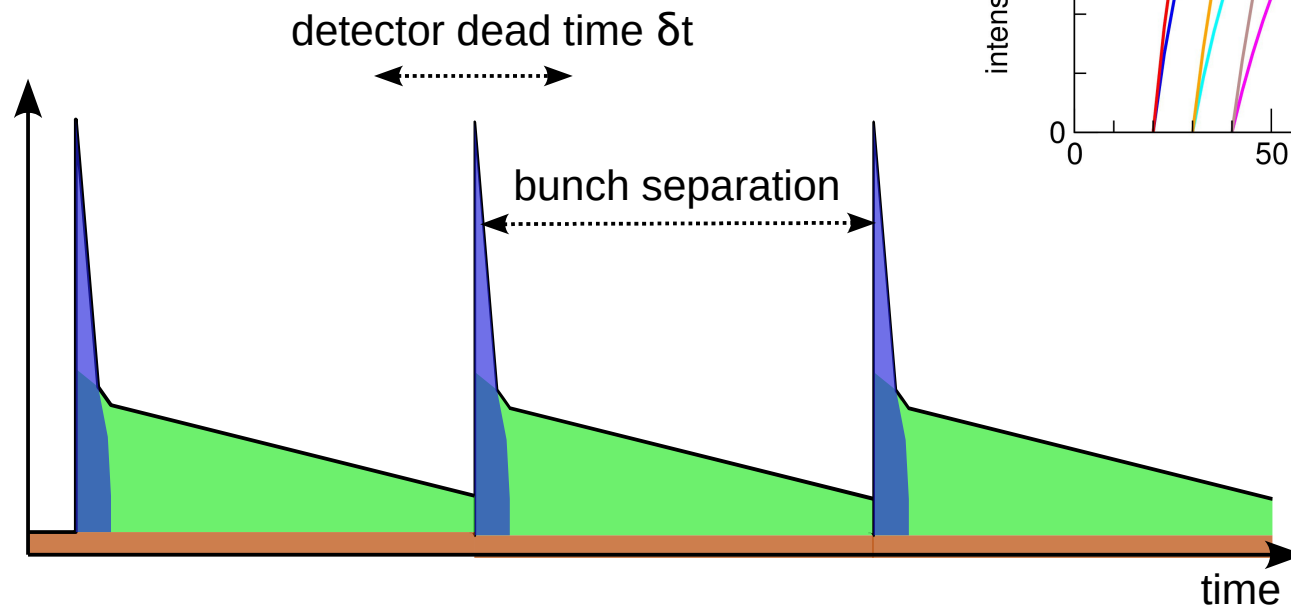

Target applications:

- perfect isotope selectivity & complete suppression of nonresonant signals
- excellent sensitivity (10^{12} nuclei in the focused beam)

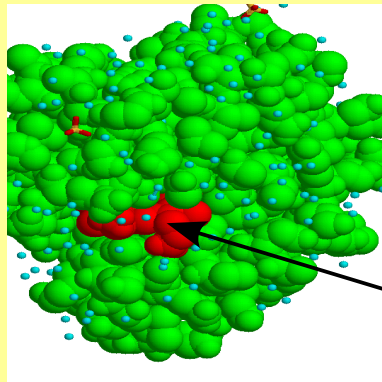

☆ proteins and other large molecules

^{57}Fe in myoglobin

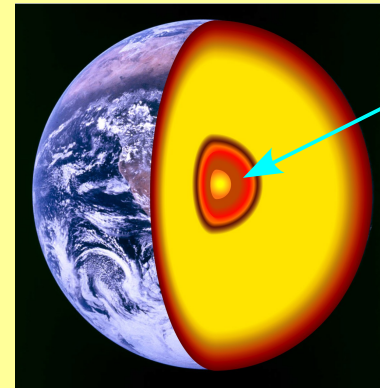

$P > 1\text{Mbar}$
 $T > 2000\text{K}$

☆ materials under high pressure



■ Cr
■ ^{56}Fe
■ ^{57}Fe

☆ nanostructures

Probes have improved models of Earth's interior:

1600's view of Earth

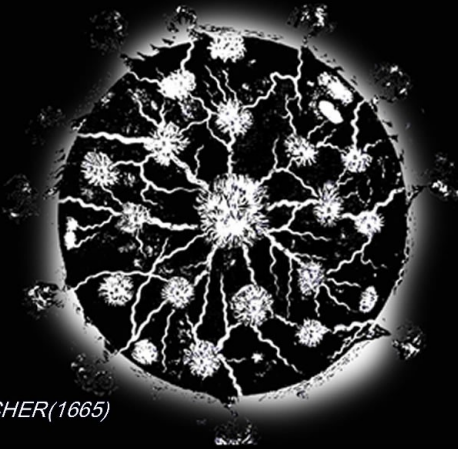

KIRCHER(1665)

1903 view of Earth



KRAEMER (1902)

1973 view of Earth

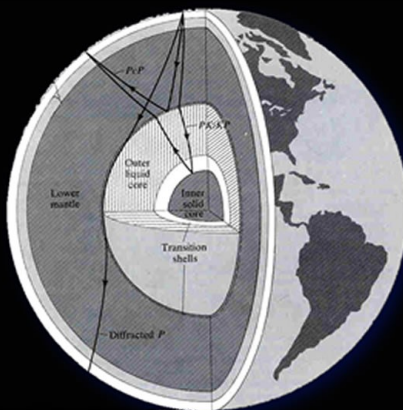

BOLT (Inside the Earth, 1973)

1990 view of Earth

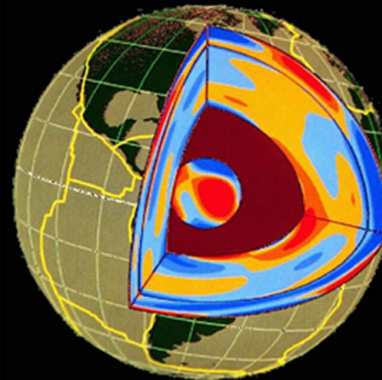

DZIEWONSKI (~1990, from www)

- ☆ seismic studies
- ☆ gravity and magnetic fields
- ☆ cosmo-chemical models
- ☆ geodynamical modeling

- ☆ material properties

Sound velocities in (Fe,Mg)SiO₃ orthoenstatites:

☆ the Debye sound velocity average is obtained from the partial phonon DOS

M. Hu et al., Phys. Rev. B 67 (2003)

W. Sturhahn and J.M. Jackson, GSA special paper 421 (2007)

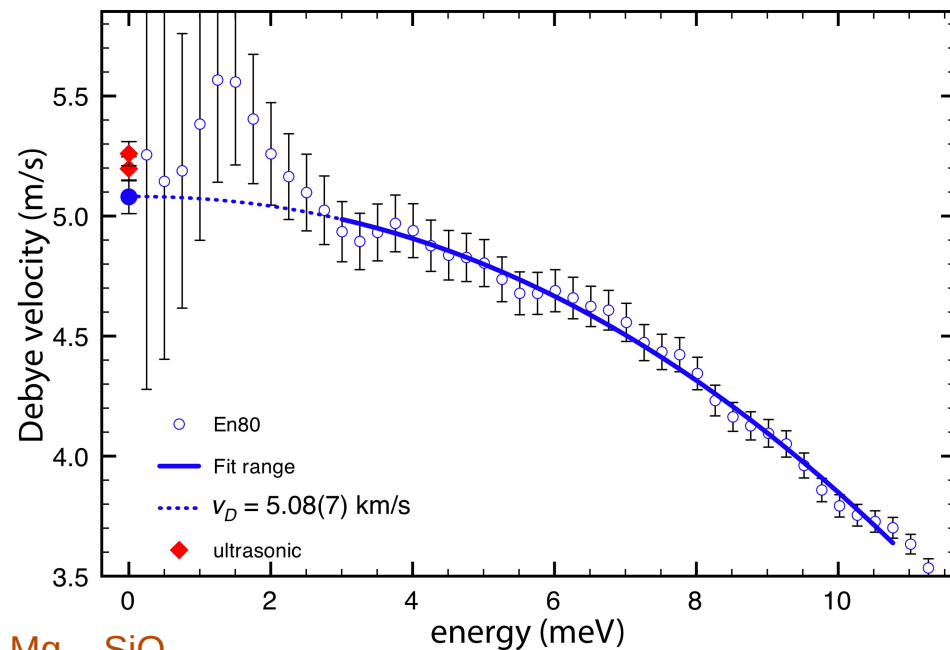
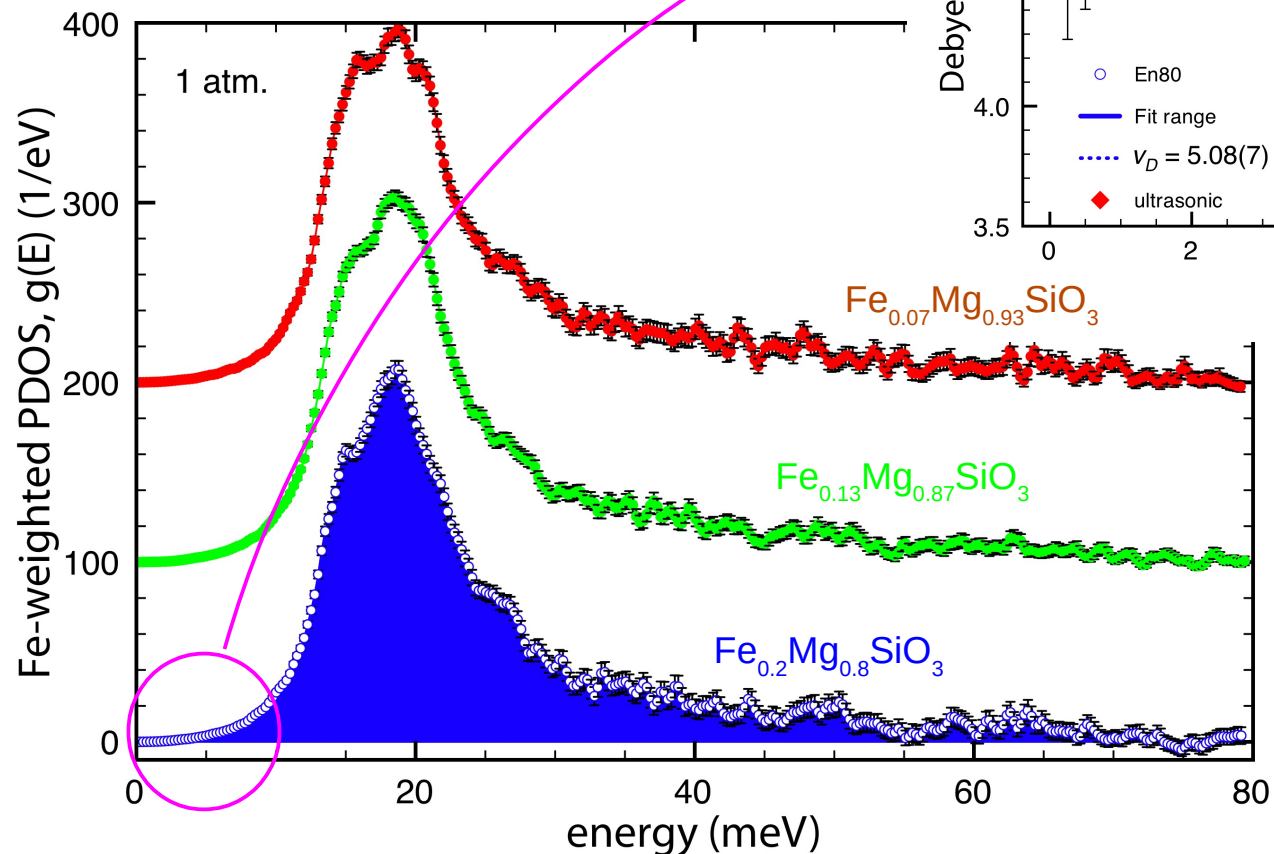

☆ excellent agreement with traditional methods

J.M. Jackson, E.A. Hamecher, W. Sturhahn, Eur. J. Mineral. 21 (2009)



Diamond anvil cells for Mbar pressures:

☆ A force applied to the diamond anvils can produce extreme pressures in a small sample chamber.

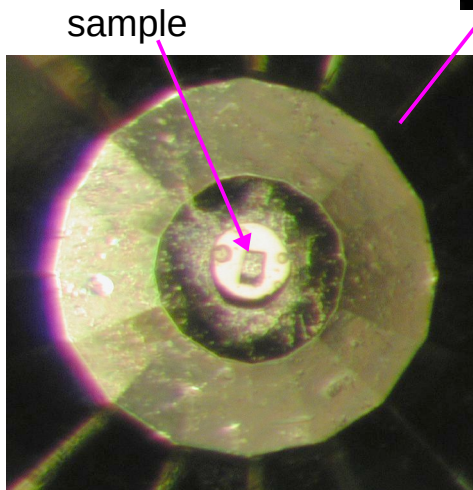
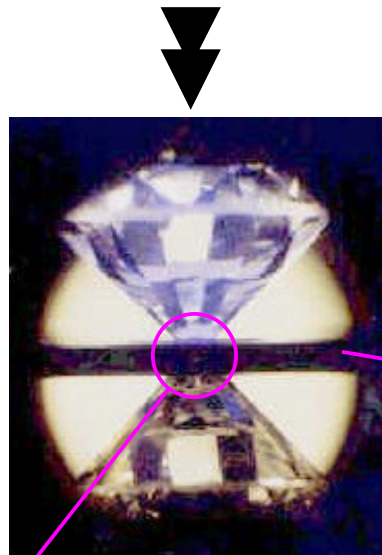

100 μm

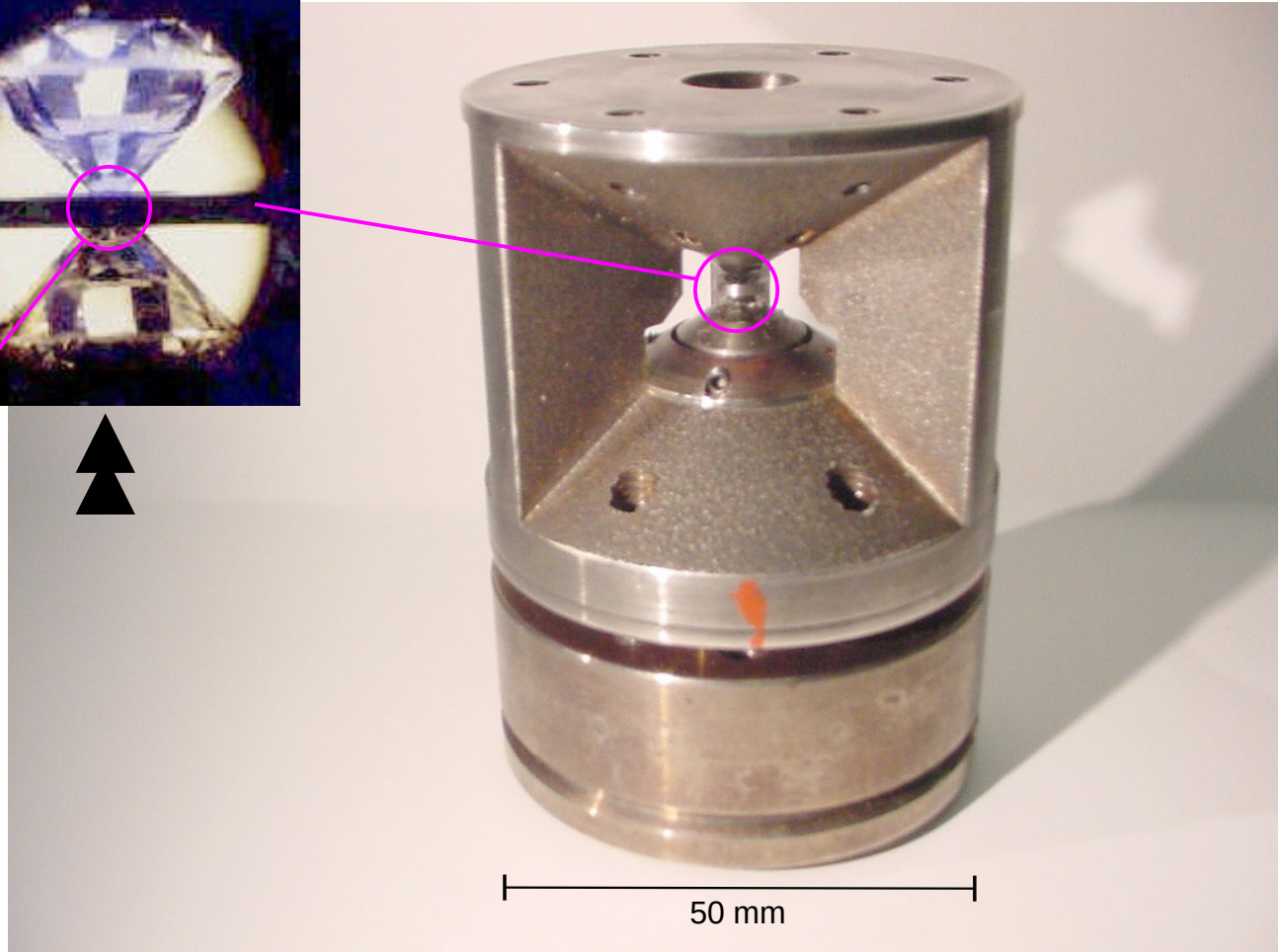

50 mm



NRIXS on hcp-Fe:

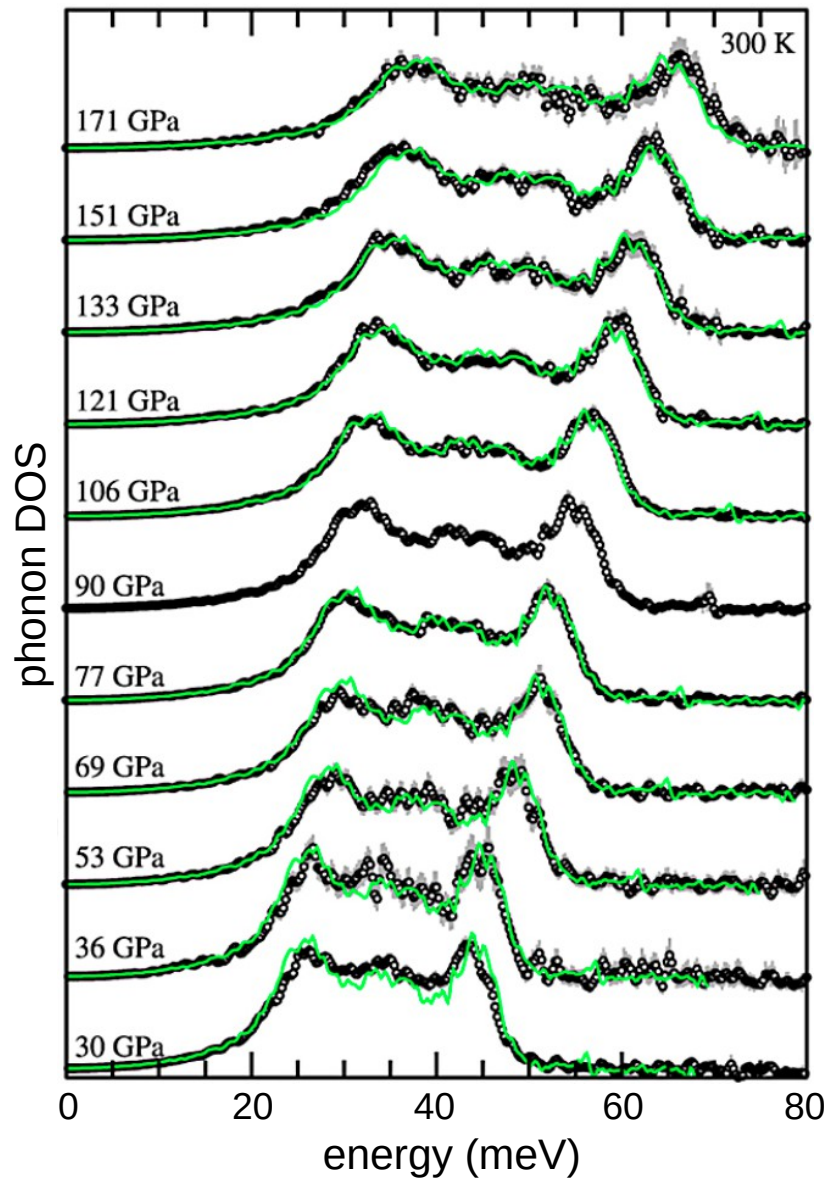

☆ hcp-Fe is the major component of Earth's core

☆ the phonon DOS of hcp-Fe shows a fairly well defined scaling behavior

$$\mathcal{D}(E, V) = \xi(V/V_i) \mathcal{D}(\xi(V/V_i) \cdot E, V_i)$$

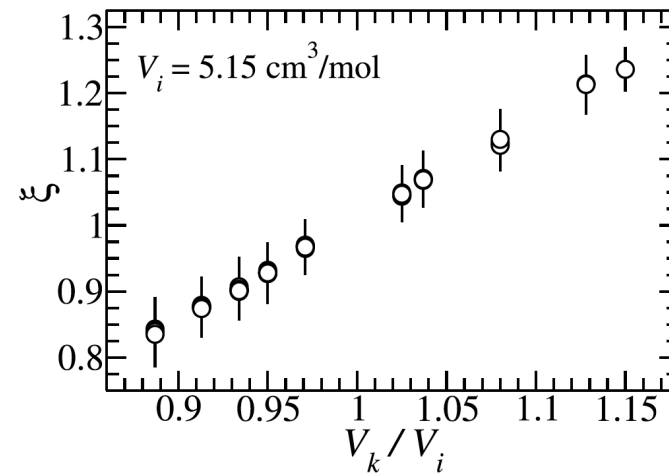

☆ the scaling gives the Grüneisen parameter

$$\gamma(V) = \gamma_0 (V/V_0)^q$$

with $\gamma_0 = 1.98(2)$ and $q = 1$

C.A.Murphy, J.M.Jackson., W.Sturhahn, B.Chen: *Geophys. Res. Lett.* 38 (2011)
 C.A.Murphy, J.M.Jackson., W.Sturhahn: *J. Geophys. Res.* 118 (2013)



NRIXS and melting:

☆ The Lindemann criterium: $\langle u^2 \rangle_{T_m} = C R^2 (T_m)$

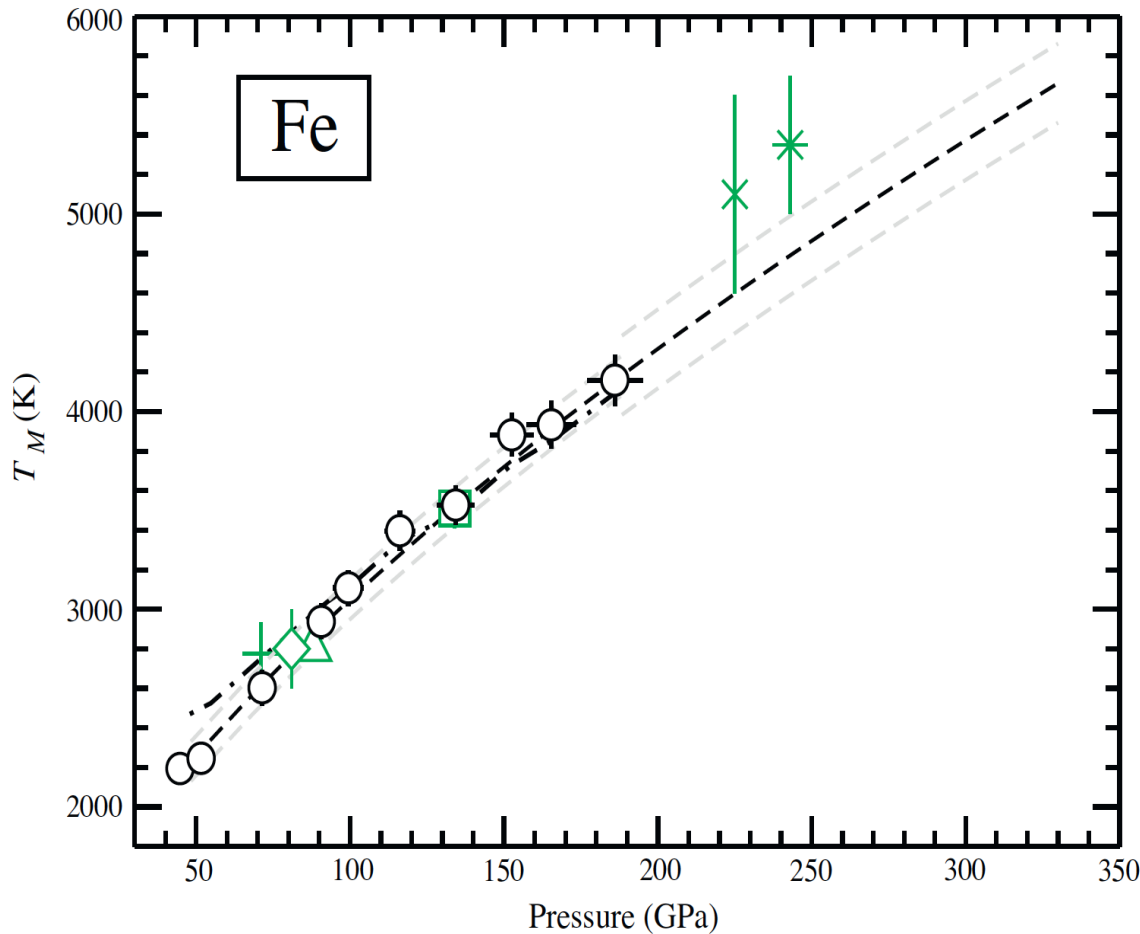

☆ from the phonon DOS of hcp-Fe we get at high temperatures

$$\begin{aligned} \langle u^2 \rangle_T &= k_B T \frac{2E_R}{3k_0^2} \int \frac{1}{E^2} \mathcal{D}(E) dE \\ &\equiv \frac{1}{k_0^2} \frac{T}{T_{LM}} \end{aligned}$$

☆ melting temperatures

$$T_m = T_{m0} \left(\frac{V}{V_{m0}} \right)^{2/3} \frac{T_{LM}(V)}{T_{LM}(V_{m0})}$$

C.A. Murphy, J.M. Jackson., W. Sturhahn, B. Chen,
Phys. Earth Planet. Inter. 188 (2011)



Biophysics applications:

- ☆ iron has several functions in biology
 - oxygen metabolism
ATP production
oxygen transport (myoglobin, hemoglobin)
 - electron transfer (cytochrome-f)
 - cellular signaling (with NO, O₂, CO)
 - active centers in enzymes, e.g.,
N₂-genase, H₂-genase

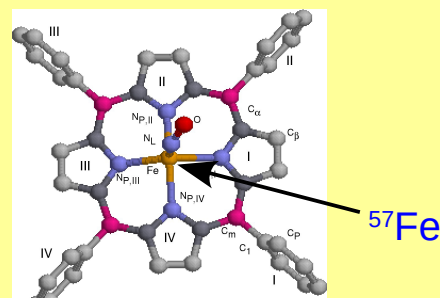
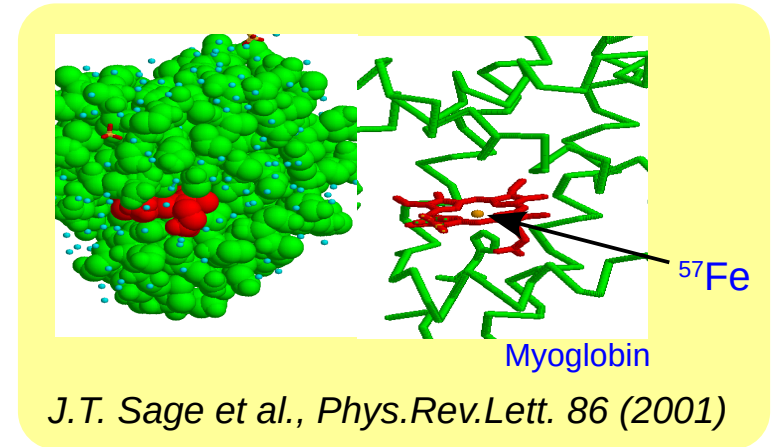

Nitrosyl-Fe(II)-tetraphenyl-porphyrin

B.K. Rai et al., Biophys.J. 82 (2002)

- ☆ NRIXS determines the complete frequency spectrum and vibration amplitudes of the probe ⁵⁷Fe located at the active site of the protein.

Phonon modes in proteins:

Cytochrome f is an electron-transfer membrane protein and part of the cytochrome b-f complex of oxygenic photosynthesis

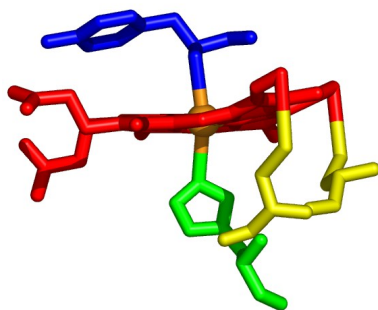
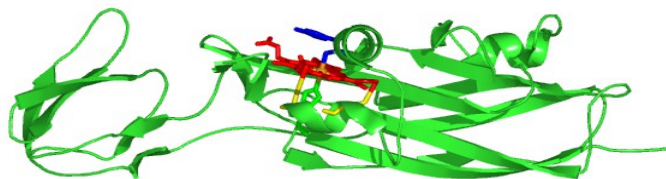

K.L. Adams et al.,
J. Phys. Chem. B 110 (2006)
B. Leu et al.,
J. Phys. Chem. B 113 (2009)

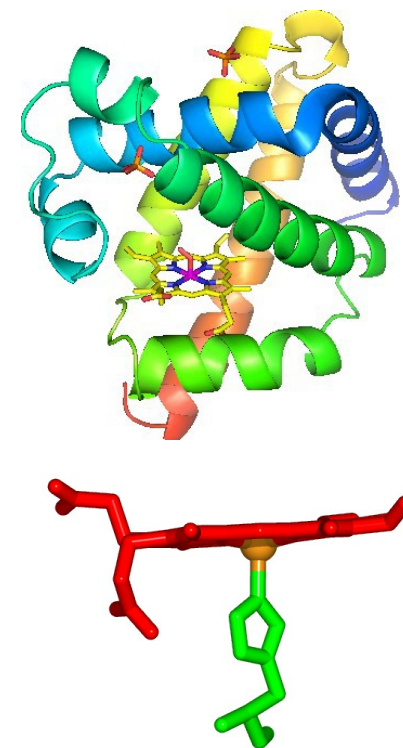
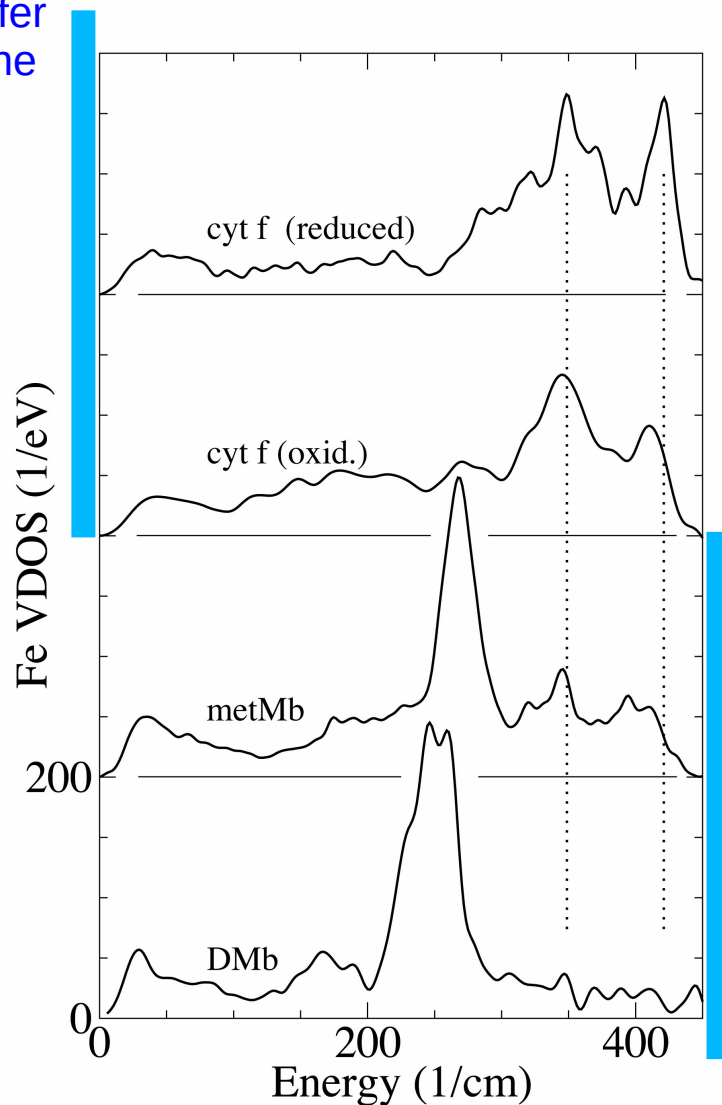

Myoglobin is an oxygen ligand-binding protein, e.g., found in muscle tissues

Polarization of phonon modes from NRIXS:

☆ [Fe(TPP)(2-Melm)] is a model system for heme proteins

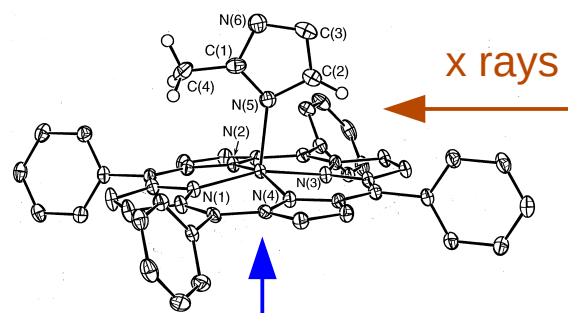

x rays
"out of plane"

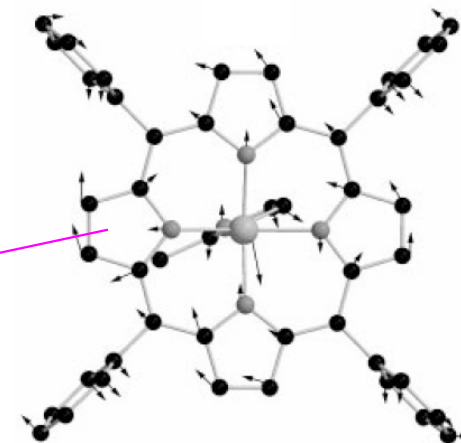
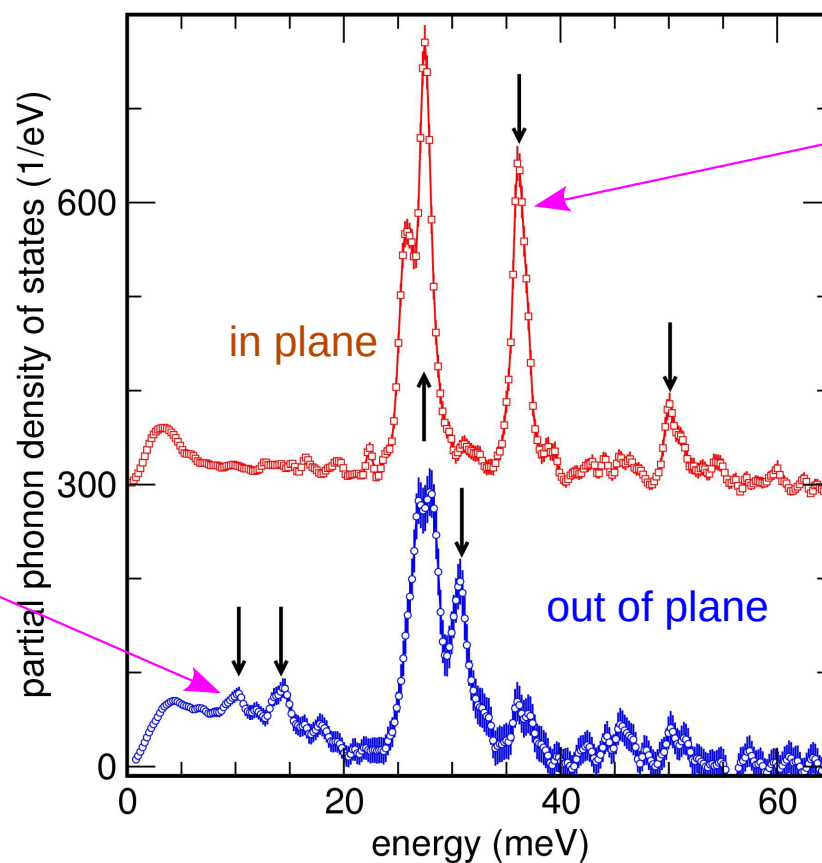
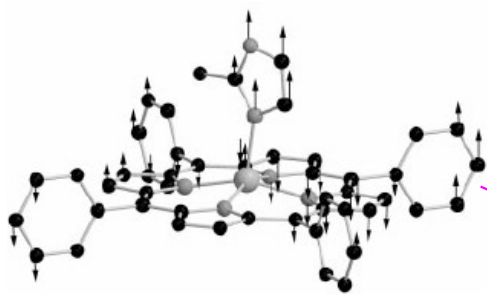

B.K. Rai et al.,
Phys.Rev. E 66 (2002)



Selection rules:

- NRIXS spectra are described by

$$S(\mathbf{k}, E) = \frac{1}{2\pi\hbar} \int \left\langle e^{i\mathbf{k}\hat{\mathbf{r}}(t)} e^{-i\mathbf{k}\hat{\mathbf{r}}(0)} \right\rangle e^{iEt/\hbar} dt$$

- The polarization of a particular phonon gives the direction of its contribution to atomic displacement.
- Phonon polarizations perpendicular to the x-rays have $\mathbf{k}\cdot\mathbf{e} = 0$ and are excluded.
- Excluded are
 - longitudinal phonons (p-waves) moving perpendicular to the x-rays;
 - transverse phonons (s-waves) moving in the direction of the x-rays.



Phonons in tracer layers:

☆ Fe films embedded in Cr show significant reduction of longitudinal modes

☆ resonant modes around 23 meV are strongly expressed

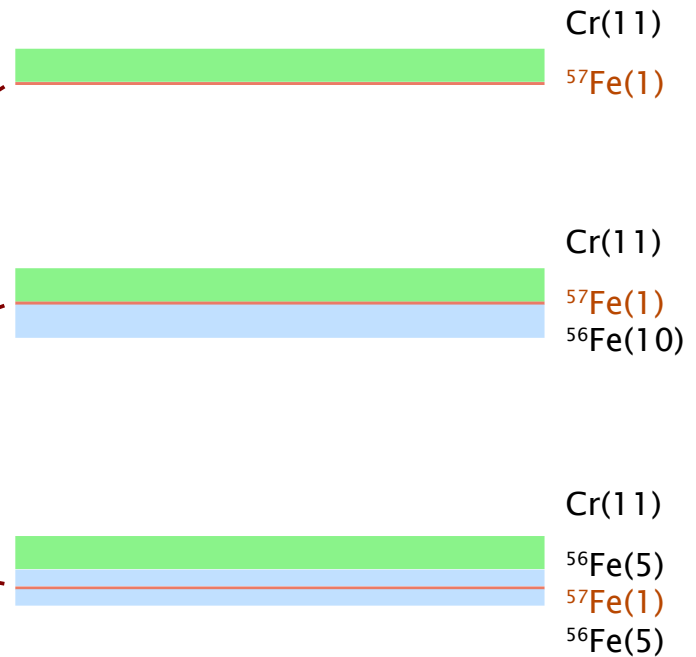
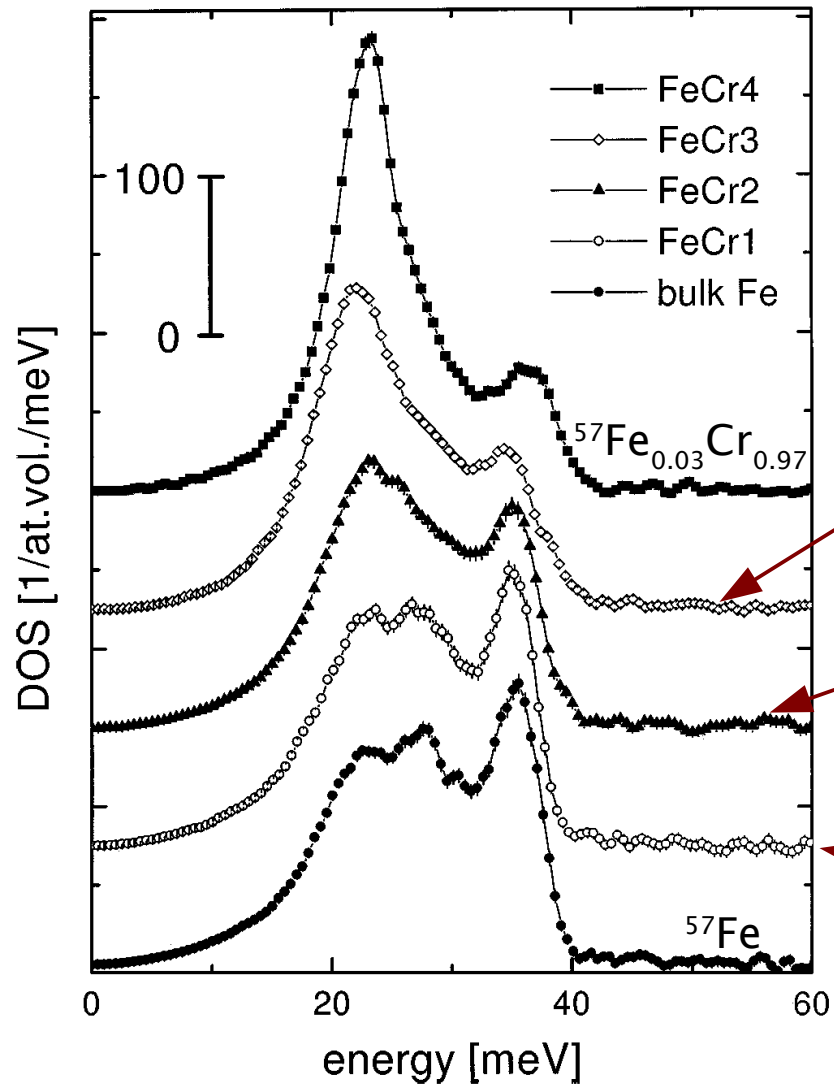

T.Ruckert, W.Keune, W.Sturhahn, M.Y.Hu, J.P.Sutter, E.E.Alp: *Hyperfine Interact.* 126 (2000)

W.Keune, S.Hong, M.Y.Hu, J.Zhao, T.S.Toellner, E.E.Alp, W.Sturhahn, T.S.Rahman, B.Roldan Cuenya: *Phys. Rev. B* 96 (2018)



Fe layers on W:

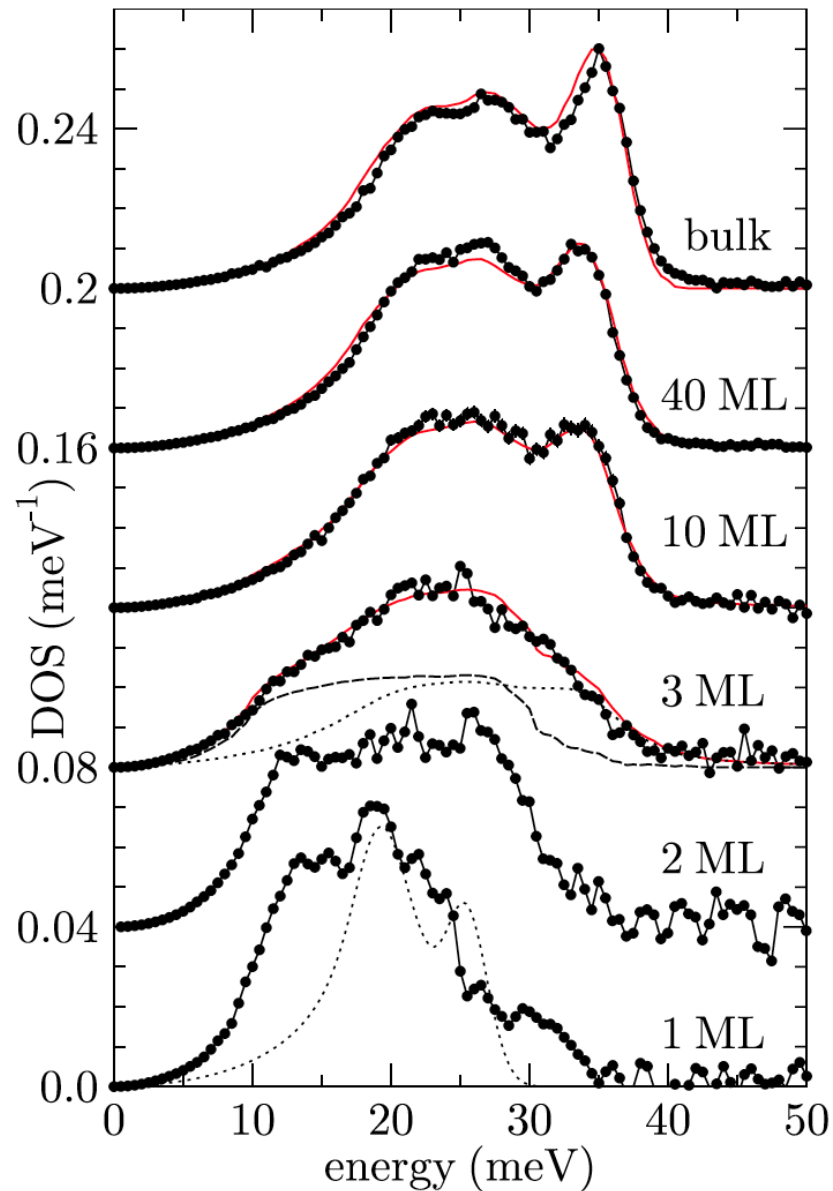

- ☆ Fe films on W also show a significant reduction of longitudinal modes
- ☆ but resonant modes around 20 meV are weakly expressed

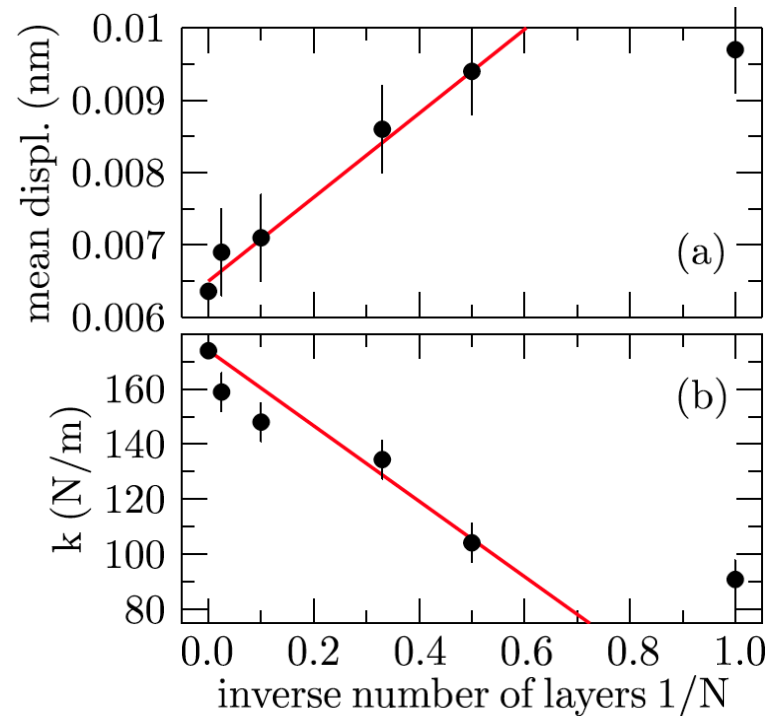

S. Stankov et al., Phys. Rev. Lett. 99 (2007)



Nano-clusters:

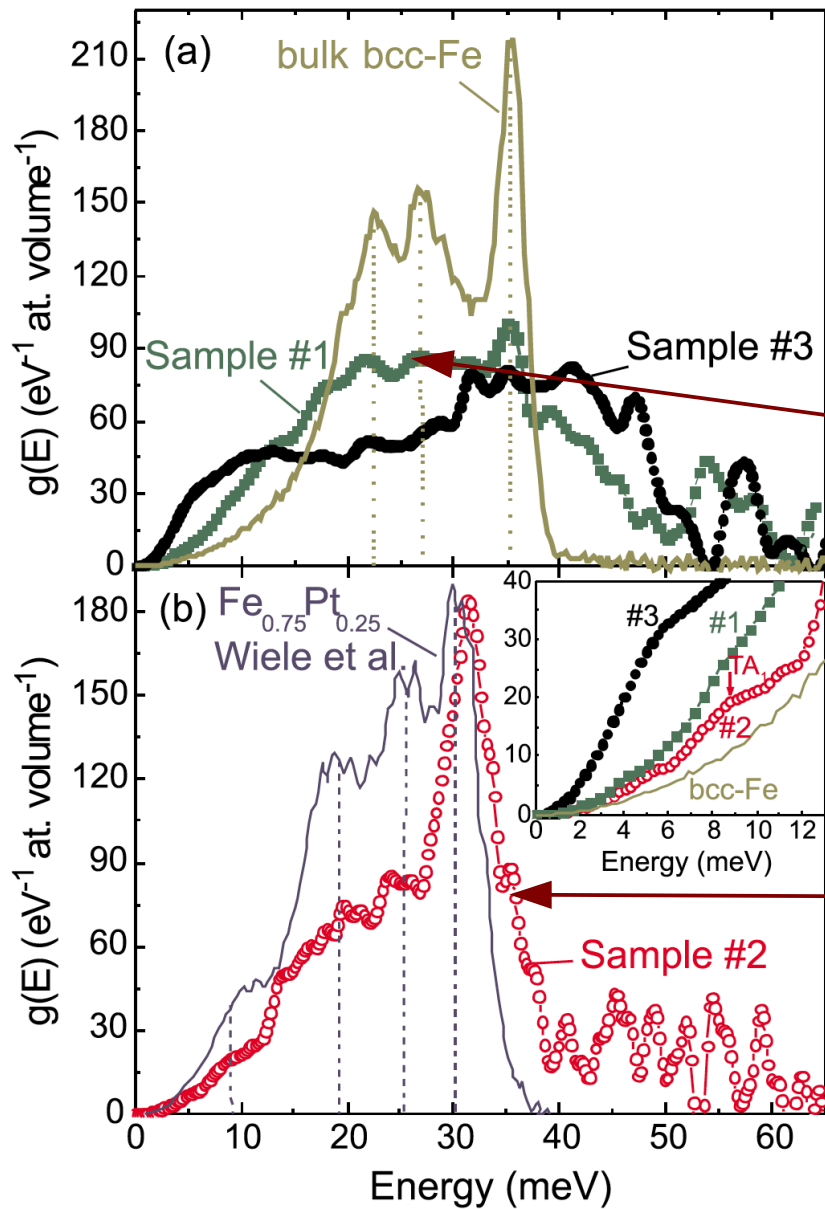

☆ self-assembled $^{57}\text{FePt}$ nano-clusters show very different phonon DOS for bcc and fcc structure

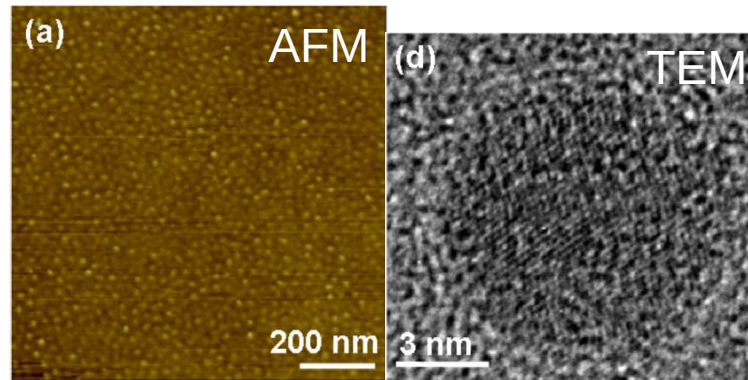

bcc structure

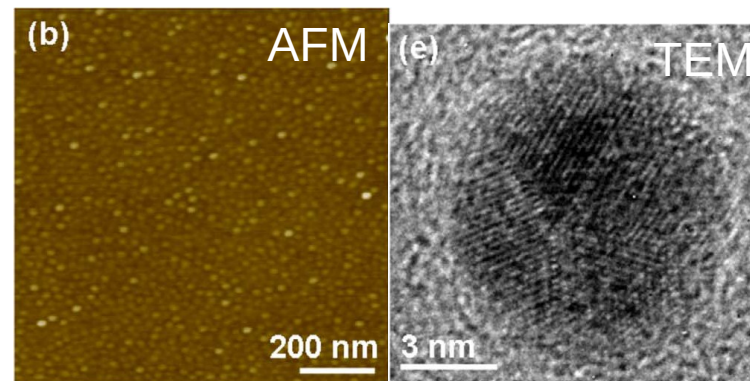

fcc structure

B. Roldan Cuenya et al., Phys. Rev. B 80 (2009)



In conclusion:

- the “three energy scales” make NRIXS work

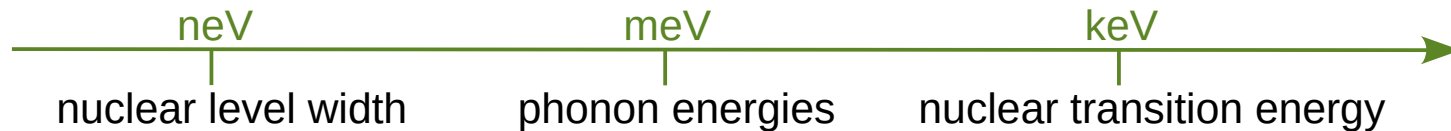

- NRIXS provides a wealth of vibrational information

- ☆ under extreme conditions (pressure, temperature)
- ☆ at active centers of proteins and enzymes
- ☆ about nano-structures

- in particular we obtain

- ☆ the partial phonon density of states



Ende